

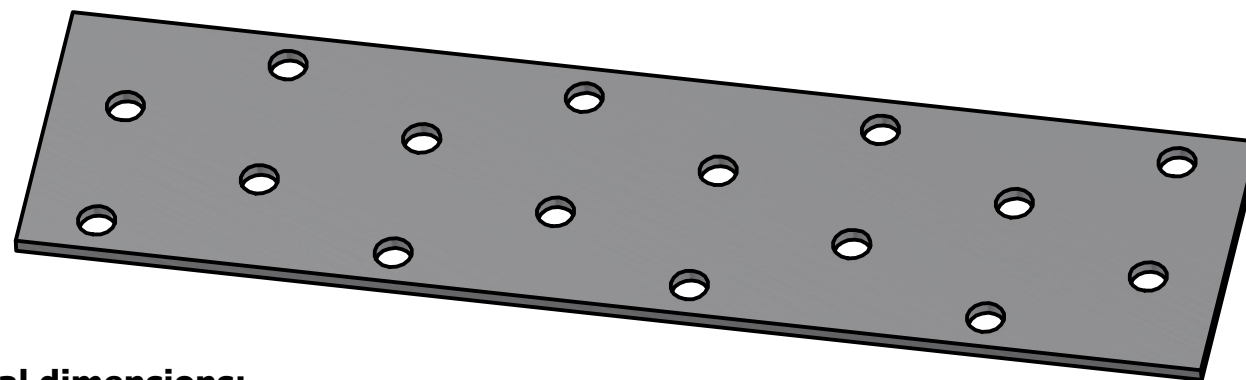

HOLE	SIZE	QTY
A	Ø5 THRU	16

General tolerances for nominal dimensions:

- Arm lengths ± 2 mm
- Product pitch ± 1 mm
- Width ± 1 mm
- Holes ± 0.4 mm



(1 : 1)

Drawn by: Vilmech	Description: Nail plate 160x40x2,0 stainless steel	
Checked by: U.K.		
Approved by: I.M.		
Date: 03.07.2025	ART: 74953	
	Size: A3	Material: A2 AISI304 STAINLESS STEEL
	Projection: 	
	M 2 : 1	Weight: 0.096 kg