

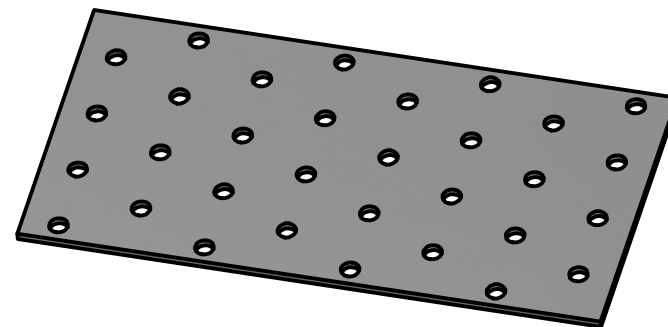

HOLE	SIZE	QTY
A	Ø5 THRU	32

**General tolerances for nominal dimensions:**

- Arm lengths  $\pm 2$  mm
- Product pitch  $\pm 1$  mm
- Width  $\pm 1$  mm
- Holes  $\pm 0.4$  mm



( 1 : 2 )

Drawn by: Vilmech	Description:	
Checked by: U.K.	Nail plate 160x80x2,0	
Approved by: I.M.	ART: 71739	
Date: 03.07.2025	Size: A3	Material: HDG DX51D + Z275/ HDG S250GD + Z275
	Projection: 	Weight: 0.191 kg
	M 1 : 1	Version: A