

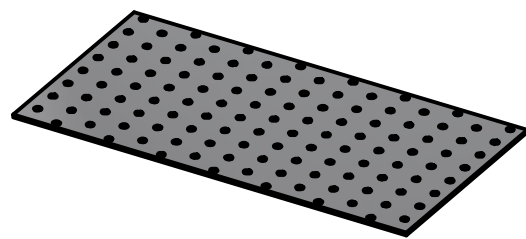

HOLE	SIZE	QTY
A	Ø5 THRU	120

General tolerances for nominal dimensions:

- Arm lengths ±2 mm
- Product pitch ±1 mm
- Width ±1 mm
- Holes ±0.4 mm



(1 : 5)

Drawn by: Vilmech	Description:	
Checked by: U.K.	Nail plate 300x160x2,0	
Approved by: I.M.	ART: 71729	
Date: 03.07.2025	Size: A3	Material: HDG DX51D + Z275/ HDG S250GD + Z275
	Projection: 	Weight: 0.717 kg
	M 1 : 1	Version: A