

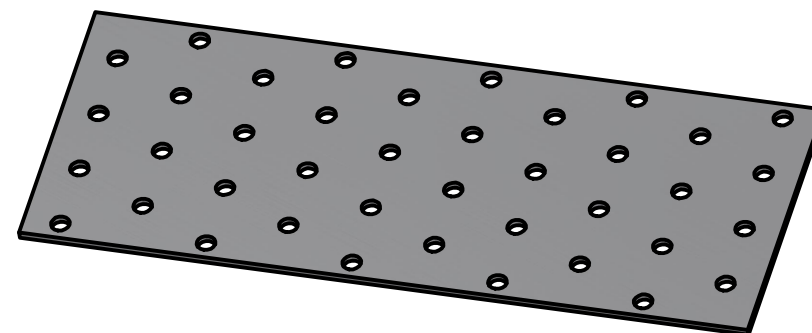

HOLE	SIZE	QTY
A	Ø5 THRU	40

General tolerances for nominal dimensions:

- Arm lengths ± 2 mm
- Product pitch ± 1 mm
- Width ± 1 mm
- Holes ± 0.4 mm



(1 : 2)

Drawn by: Vilmech	Description:	
Checked by: U.K.	Nail plate 200x80x2,0	
Approved by: I.M.	ART: 71716	
Date: 03.07.2025	Size: A3	Material: HDG DX51D + Z275/ HDG S250GD + Z275
	Projection: 	Weight: 0.239 kg
	M 1 : 1	Version: A